



GIEBEL
FilTec GmbH

**DESIGNED AND
PRODUCED
IN GERMANY**





VENTILATION DRYER FOR GEARS

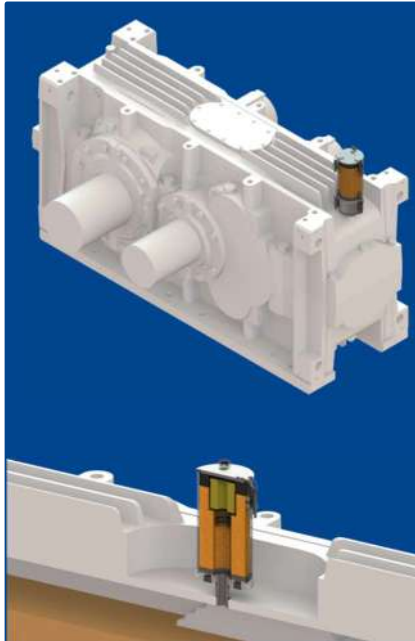

Due to temperature fluctuations between operation and standstill, the air volume in a transmission changes constantly. Sucked, humid ambient air significantly reduces the service life of a gear oil.

Furthermore, moisture in the housing leads to corrosion with particle abrasion and thus damage to the gearbox.

Good transmission ventilation filters prevent the ingress of humidity during the "breathing" of the transmission. GIEBEL Adsorber® are special gear ventilation filters for anhydrous ventilation.

For example, these respiratory dryers are used successfully near the coast, on offshore installations, in tropical regions and underground.





USE OF A BREATHER DRYER

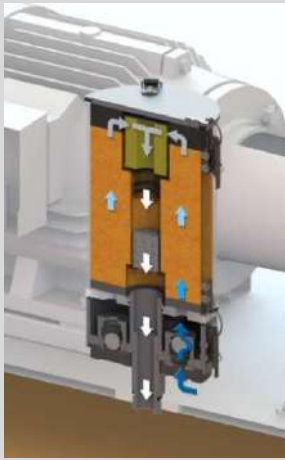

Targets: Drying of sucked, incoming air, avoiding condensation damage

Function: Drying by a desiccant, cleaning of the air by a filter element, protection of the desiccant by frost-proof valves, use of self-regeneration to extend the maintenance intervals

Solution: Dry and filtered air in the hydraulic tank, dew point of up to -30 °C and residual moisture at approx. 2-20% rh, no damage due to condensation

USE OF AN OIL MIST SEPARATOR



Targets: Protecting the environment from contamination with oil mist, Secondary protection against atmospheric moisture from the ambient air

Function: Binding of larger oil particles, which drops back into the tank due to condensation, adsorption of small particles of oil through activated carbon, drying of the incoming air

Solution: No leakage of oil particles from the hydraulic tank, cleaning of surfaces not necessary, protection of hydraulic oil from humidity.



USE OF A WATER DRP SEPARATOR

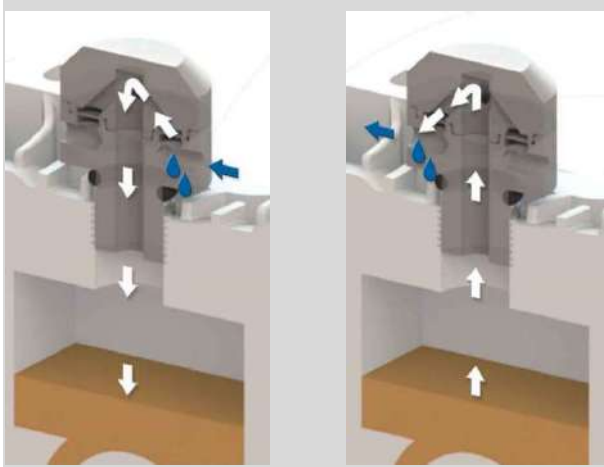

Targets: Protection of the gearbox against water entry; Ensuring the free breathing of the transmission

Function: Separation of water droplets and mist, breathing of the gearbox in both directions, no adsorption of humidity

Solution: No inflow of water drops into the transmission, free breathing and no entry of dirt particles

REFERENCES









ADSORBER GEARS



Adsorber	VENT PA-D	VENT PA-R	VARIO PA-D	VARIO PA-R	VARIO MA-D	VARIO MA-R	VARIO ME-D	VARIO ME-R	VARIO VG PA-D	VARIO VG PA-R	HSECU RE
Usage	Breather Dryer								Oil Mist Separator		Water Drop Separator
Valves	✗	✗	✓	✓	✓	✓	✓	✓	✗	✗	
Rechargeable	✗	✓	✗	✓	✗	✓	✗	✓	✗	✓	
According ATEX 2014	✗	✗	✗	✗	✓	✓	✓	✓	✗	✗	
Offshore suitable	✗	✗	✗	✗	✗	✗	✓	✓	✗	✗	
Gear volume (Oil and Air volume)											
0 – 5 l	vV 120-PA 05.0010.36	vV 130-PA 05.0010.27	vV 120-PA 05.0010.43	vV 130-PA 05.0010.37							hs 30-PC 02.0000.07
5 – 10 l	vV 140-PA 05.0010.42	vV 150-PA 05.0010.28	vV 140-PA 05.0010.44	vV 150-PA 05.0010.17							
10 – 50 l	vV 200-PA 05.0020.29	vV 210-PA 05.0020.56	vV 200-PA 05.0020.64	vV 210-PA 05.0020.30							hs 50-PC 02.0000.06
50 – 100 l	vV 220-PA 05.0020.32	vV 230-PA 05.0020.78	vV 220-PA 05.0020.25	vV 230-PA 05.0020.33	vV 220-MA 05.0030.97	vV 230-MA 05.0030.90					
100 – 800 l	vV 300-PA 05.0030.50	vV 310-PA 05.0030.53	DV 300-PA 07.0001.19	DV 310-PA 07.0000.24	DV 300-MA 07.0001.58	DV 310-MA 07.0000.53	DV 300-ME 07.0001.27	DV 310-ME 07.0001.09	DV VG 320-PA 07.0001.56	DV VG 330-PA 07.0001.57	
800 – 2400 l	vV 320-PA 05.0030.93	vV 330-PA 05.0030.19	DV 320-PA 07.0001.02	DV 330-PA 07.0001.20	DV 320-MA 07.0001.53	DV 330-MA 07.0001.26	DV 320-ME 07.0001.46	DV 330-ME 07.0001.41	DV VG 500-PA 08.0002.02	DV VG 530-PA 08.0002.05	
2400 – ... l	vV 500-PA 05.0060.16	vV 510-PA 05.0060.10	DV 500-PA 08.0000.50	DV 510-PA 08.0000.51	DV 500-MA 08.0003.31	DV 510-MA 08.0003.09	DV 500-ME 08.0003.00	DV 510-ME 08.0003.01	DV VG 550-PA 08.0002.08	DV VG 560-PA 08.0002.15	



ACCESSORIES

Accessories											
Oil separator 	OSD-130 03.2135.07	OSD-130 03.2135.07	OSD-130 03.2135.07	OSD-130 03.2135.07	OSD-180 03.2132.00	OSD-180 03.2132.00	OSD-180 03.2135.05	OSD-180 03.2135.05	OSD-130 03.2135.07	OSD-130 03.2135.07	
	OSD-180 03.2132.00	OSD-180 03.2132.00	OSD-180 03.2132.00	OSD-180 03.2132.00					OSD-180 03.2132.00	OSD-180 03.2132.00	
Wall mount 	WH-oSL-HK 03.0000.89	WH-oSL-HK 03.0000.89	WH-oSL-5 03.0000.90	WH-oSL-5 03.0000.90	WH-oSL-5 03.0000.90	WH-oSL-5 03.0000.90	WH-oSL-5 03.0000.90	WH-oSL-5 03.0000.90	WH-oSL-5 03.0000.90	WH-oSL-5 03.0000.90	WH-oSL-HK 03.0000.89
	WH-oSL-5 03.0000.90	WH-oSL-5 03.0000.90	WH-SL-3 03.0000.56	WH-SL-3 03.0000.56	WH-SL-3 03.0000.56	WH-SL-3 03.0000.56	WH-SL-3 03.0000.56	WH-SL-3 03.0000.56	WH-SL-3 03.0000.56	WH-SL-3 03.0000.56	WH-oSL-5 03.0000.90
Assembly tube 	AT-I250 03.0000.71	AT-I250 03.0000.71	AT-I250 03.0000.71	AT-I250 03.0000.71	AT-I250 03.0000.71	AT-I250 03.0000.71	AT-I250 03.0000.71	AT-I250 03.0000.75	AT-I250 03.0000.71	AT-I250 03.0000.71	
	AT-LK250 03.0000.82	AT-LK250 03.0000.82	AT-LK250 03.0000.82	AT-LK250 03.0000.82	AT-LK250 03.0000.82	AT-LK250 03.0000.82	AT-LK250 03.0000.82		AT-LK250 03.0000.82	AT-LK250 03.0000.82	
Protection adapter 	PRT-AD 08.2104.01	PRT-AD 08.2104.01	PRT-AD 08.2104.01	PRT-AD 08.2104.01	PRT-AD 08.2104.01	PRT-AD 08.2104.01	PRT-AD 08.2104.03	PRT-AD 08.2104.03	PRT-AD 08.2104.01	PRT-AD 08.2104.01	
Bypass adapter 	BPA-AD 08.0000.71	BPA-AD 08.0000.71	BPA-AD 08.0000.71	BPA-AD 08.0000.71	BPA-AD 08.0000.71	BPA-AD 08.0000.71	BPA-AD 08.0000.70	BPA-AD 08.0000.70	BPA-AD 08.0000.71	BPA-AD 08.0000.71	

APPLICATIONS

GIEBEL Adsorber® are used for example:

- Turbines & generators in hydroelectric power plants
- Paper machines
- Vertical drilling rigs (Onshore)
- Gears and pumps for offshore drilling rigs
- Gears in sugar processing
- Extruder gearbox for injection molding machines
- Circulation basin in sewage treatment plants
- Ship gearbox / propeller
- Cable cars and ski lifts
- and many more !





Contact your nearest branch:

WA	Kewdale WA (National H/Office) 67 Kewdale Road Kewdale WA 6105 Ph: (08) 9352 2200 Belmont Ph: (08) 9478 2444 Kalgoorlie Ph: (08) 9091 4111	Bunbury Bearings Ph: (08) 9721 3522 Bunbury Ph: (08) 9724 9100 Karratha Ph: (08) 9144 2333 Wangara Ph: (08) 9303 6900	Albany Ph: (08) 9842 2488 Collie Ph: (08) 9734 1624 Linear Head Office Ph: (08) 9475 5000	Bibra Lake Ph: (08) 9434 9555 Geraldton Ph: (08) 9964 4655 Naval Base Ph: (08) 9410 1800
QLD	Coopers Plains (State H/Office) 902 Beaudesert Road Coopers Plains QLD 4108 Ph: (07) 3717 4444 Virginia Ph: (07) 3265 2666	Coopers Plains Linear dept Ph: (07) 3717 4452 Mackay Ph: (07) 4952 6660	Cairns Ph: (07) 4035 1800 Rockhampton Ph: (07) 4927 2677	Townsville Ph: (07) 4758 8855
NSW	Smithfield (State H/Office) Unit 4, 8 Cooper Street Smithfield NSW 2164 Ph: (02) 9616 0000	Beresfield (Newcastle) Ph: (02) 4041 6444	Smithfield Linear dept Ph: (02) 9616 0066	Wollongong Ph: (02) 4272 2377
VIC	Dandenong South (State H/Office) 84 Greens Road Dandenong Sth VIC 3175 Ph: (03) 8710 9777	Dandenong South Linear dept Ph: (03) 9755 6044	Somerton Ph: (03) 9308 0055	Traralgon Ph: (03) 5172 3000
SA	Wingfield (State H/Office) 13 Streiff Road Wingfield SA 5013 Ph: (08) 8260 6299	Wingfield Linear dept Ph: (08) 8260 6299	TAS	Hobart 39 Sunderland Street Derwent Park TAS 7009 Ph: (03) 6216 6999
	INDONESIA Ph: (62) 542 7031166			

